

The all new **TERRAIN**<sup>®</sup>  
say HELLO to

**THE ELECTRIC WORLD**

**CORVUS**

**TERRAIN**

**EX4**

---

# EX4



# EX4





**EX4**



**TERRAIN**

*Electric*



**EX4**

# MAIN SPECIFICATIONS

## CORVUS TERRAIN EX4



**BATTERY ION-LITIO 15 KWH**

**ENGINE POWER NOMINAL** 13 KW / 17,43 HP  
**ENGINE POWER PEAK** 28 KW / 37,5 HP

**TORQUE** 150 NM

**BATTERY CHARGING CAPACITY** 2,4 KW (AC)

DRIVING MODE / ESTIMATED RANGE:

**RANGE** 100 KM (DEPENDING ON USE)

**POWER** (DEPENDING ON USE)



# EX4

# MAIN SPECIFICATIONS

## CORVUS TERRAIN EX4



**TRANSMISSION**  
4X2-4X4 TRACTION AND REAR  
DIFFERENTIAL LOCK



**MAXIMUM SPEED IN LOW** 25 KM/H  
**MAXIMUM SPEED IN HIGH** 40 KM/H



**LOADING  
CAPACITY**  
300 KG



**PULLING  
CAPACITY**  
IN LOW 755 KG  
IN HIGH 479 KG



**ANTI-FOG HEATED  
WINDSCREEN**















# EQUIPMENT

## CORVUS TERRAIN EX4

### BASE

















-  4x4/4x2 system
-  Rear diff. lock
-  Cargo bed
-  Skid plate
-  BASIC roof
-  Adjustable seats
-  2 point safety belt
-  Front hitch receiver
-  Tow ball
-  Adjustable suspension
-  Bottle storage























### BASE EPS

-  Electric power steering EPS

### PRO EPS

-  4x4/4x2 system
-  Rear diff. lock
-  Cargo bed
-  Skid plate
-  BASIC roof
-  Adjustable seats
-  2 point safety belt
-  Front hitch receiver
-  Tow ball
-  Adjustable suspension
-  Bottle storage
-  Electric power steering EPS
-  Laminated Windscreen
-  Front wiper system
-  Rear screen
-  Under-seat compartments.
-  Inner rearview mirror

### CAB

-  4x4/4x2 system
-  Rear diff. lock
-  Cargo bed
-  Skid plate
-  ADVANCED roof
-  Adjustable seats
-  2 point safety belt
-  Front hitch receiver
-  Tow ball
-  Adjustable suspension
-  Bottle storage
-  Electric power steering EPS
-  Laminated Windscreen
-  Front wiper system
-  Rear screen
-  Under-seat compartments.
-  Inner rearview mirror
-  Doors
-  Courtesy light
-  Front storage boot



# NEW SPEEDOMETER

CORVUS  
**TERRAIN EX4**



 **EX4**

# CHASSIS



**EX4**

# POWER TRAIN

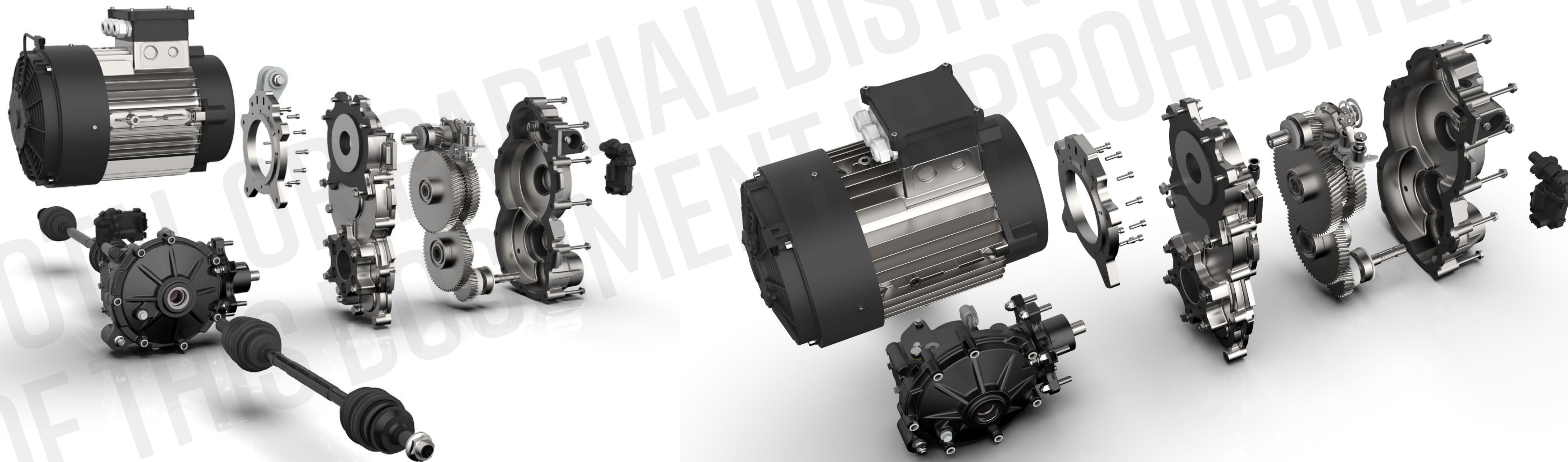

**WORK DIFFERENT.  
DO EFFICIENTLY.**





**CORVUS**